

JVC

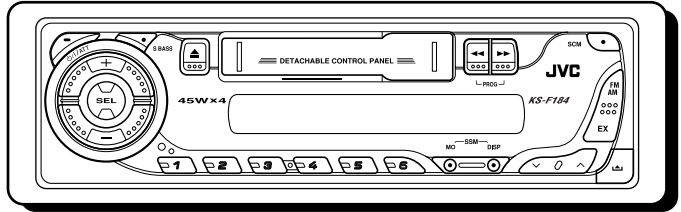

CASSETTE RECEIVER

KS-F184

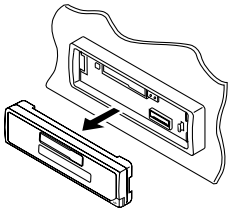

For installation and connections, refer to the separate manual.

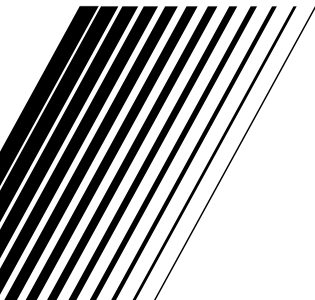

INSTRUCTIONS

Thank you for purchasing a JVC product.

Please read all instructions carefully before operation, to ensure your complete understanding and to obtain the best possible performance from the unit.

CONTENTS

How to reset your unit	2	TAPE OPERATIONS	9
LOCATION OF THE BUTTONS	3	Listening to a cassette	9
Control panel	3	SOUND ADJUSTMENTS	10
BASIC OPERATIONS	4	Adjusting the sound	10
Turning on the power	4	Turning on/off the super bass function	10
Setting the clock	5	Selecting preset sound modes	11
RADIO OPERATIONS	6	Storing your own sound adjustments	11
Listening to the radio	6	DETACHING THE CONTROL PANEL	12
Storing stations in memory	7	TROUBLESHOOTING	13
Tuning in to a preset station	8	MAINTENANCE	14
Storing your favorite station in to the one-touch operation button (EX—extra)	8	SPECIFICATIONS	15

How to reset your unit

While holding SEL (select), press **⏻/ATT** (standby/on/attenuator) button for more than 2 seconds. This will reset the built-in microcomputer.

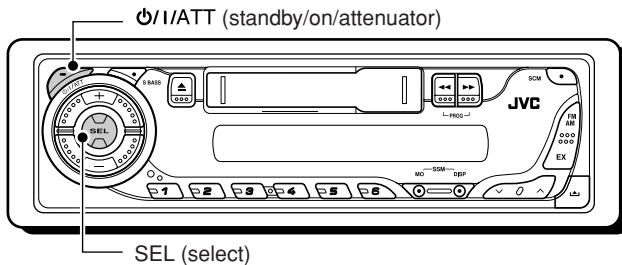

Note:

Your preset adjustments—such as preset channels or sound adjustments—will also be erased.

BEFORE USE

For safety....

- Do not raise the volume level too much, as this will block outside sounds, making driving dangerous.
- Stop the car before performing any complicated operations.

Temperature inside the car....

If you have parked the car for a long time in hot or cold weather, wait until the temperature in the car becomes normal before operating the unit.

LOCATION OF THE BUTTONS



Control panel

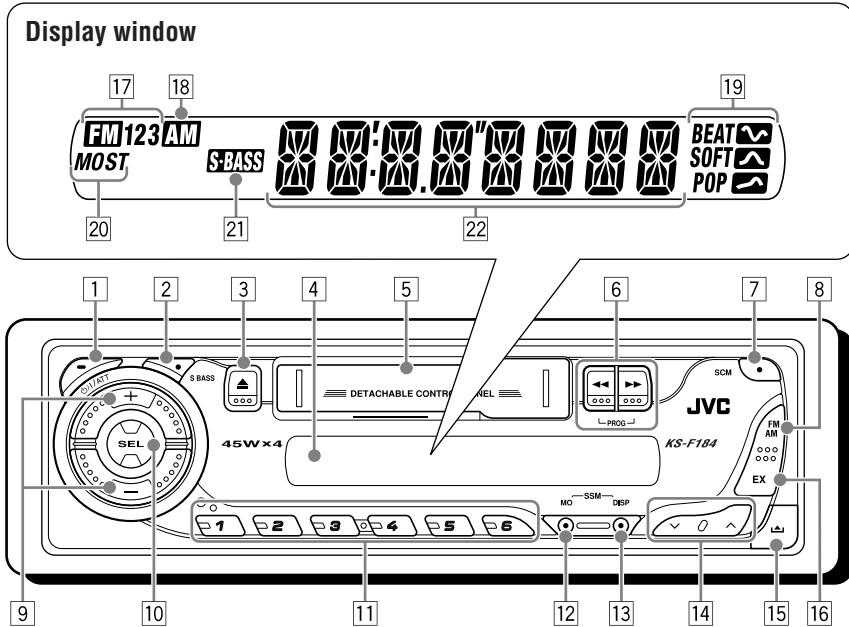

1 **I/ATT** (standby/on/attenuator) button

2 **S BASS** (super bass) button

3 **▲** (eject) button

4 Display window

5 Cassette compartment

6 **◀▶** **PROG** (program) button

7 **SCM** (sound control memory) button

8 **FM AM** button

9 **+/-** buttons

10 **SEL** (select) button

11 Number buttons

12 **MO** (monaural) button

- Also functions as **SSM** buttons when pressed together with **DISP** (display) button.

13 **DISP** (display) button

- Also functions as **SSM** buttons when pressed together with **MO** (monaural) button.

14 **▼ / ▲** buttons

15 **▲** (control panel release) button

16 **EX** (extra) button

Display window

17 **FM** band indicators

FM1, FM2, FM3

18 **AM** band indicator

19 Sound mode indicators

BEAT, SOFT, POP

20 Tuner reception indicators

MO (monaural), ST (stereo)

21 **S-BASS** (super bass) indicator

22 Main display



BASIC OPERATIONS

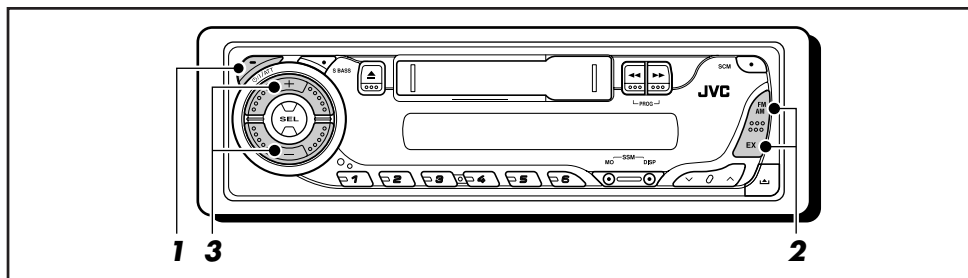

Turning on the power

1 Turn on the power.



Note on One-Touch Operation:

When you select a source in step 2 below, the power automatically comes on. You do not have to press this button to turn on the power.

2 Select the source.

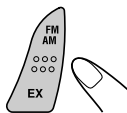

To operate the tuner (FM or AM), see pages 6 – 8.

To operate the EX (extra) button, see page 8.

To play a tape, see page 9.

3 Adjust the volume.

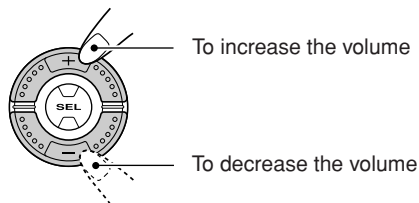

Volume level appears.

4 Adjust the sound as you want. (See pages 10 and 11.)

To drop the volume in a moment

Press **I/ATT** briefly while listening to any source. "ATT" starts flashing on the display, and the volume level will drop in a moment.

To resume the previous volume level, press the button briefly again.

To turn off the power

Press and hold **I/ATT** for more than one second.

"SEE YOU" appears, then the unit turns off.

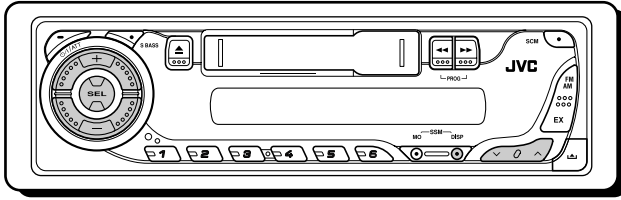

Setting the clock

- 1** Press and hold SEL (select) for more than 2 seconds.



"CLOCK H" or "CLOCK M" appears on the display.

- 2** Set the hour.

- 1 Select "CLOCK H" (hour) if not shown on the display.
- 2 Adjust the hour.

1

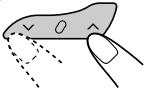

2

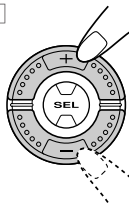

- 3** Set the minute.

- 1 Select "CLOCK M" (minute).
- 2 Adjust the minute.

1

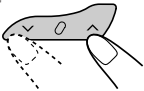

2



- 4** Finish the setting.



To check the current clock time or change the display mode

DISP



Press DISP (display) repeatedly. Each time you press the button, the display mode changes as follows:

- During tuner operation:

Frequency ↔ Clock

- During tape operation:

Play mode (TAPE) ↔ Clock

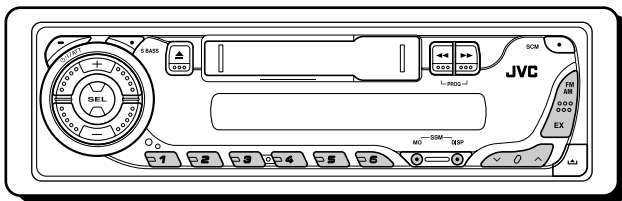

Listening to the radio

You can use either automatic searching or manual searching to tune in to a particular station.

Note:

When a cassette is in the cassette compartment, you cannot select the tuner. Be sure to eject the cassette from the cassette compartment to listen to the radio.

Searching for a station automatically: Auto search

1 Select the band (FM1 – 3, AM).

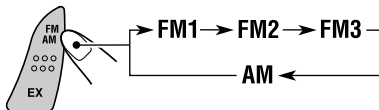

Selected band appears.



Lights up when receiving an FM stereo broadcast with sufficient signal strength.

Note:

This receiver has three FM bands (FM1, FM2, FM3). You can use any one of them to listen to an FM broadcast.

2 Start searching for a station.

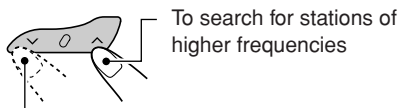

To search for stations of higher frequencies

To search for stations of lower frequencies

When a station is received, searching stops.

To stop searching before a station is received, press the same button you have pressed for searching.

Searching for a station manually: Manual search

1 Select the band (FM1 – 3, AM).



Note:

This receiver has three FM bands (FM1, FM2, FM3). You can use any one of them to listen to an FM broadcast.

2 Press and hold ^ or v until "M" (manual) starts flashing on the display.

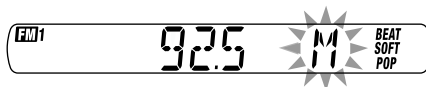
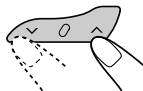

3 Tune in to a station you want while "M" (manual) is still flashing.

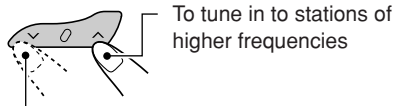

To tune in to stations of higher frequencies

To tune in to stations of lower frequencies

- If you release your finger from the button, the manual mode will automatically turn off after 5 seconds.
- If you hold down the button, the frequency keeps changing (in 50 kHz intervals for FM and 9 kHz intervals for AM) until you release the button.

When an FM stereo broadcast is hard to receive:



Press MO (monaural), while listening to an FM stereo broadcast. Each time you press the button, the MO indicator lights up and goes off alternately.



MO (monaural) indicator

When the MO indicator is lit on the display, the sound you hear becomes monaural but the reception will be improved.

To restore the stereo effect, press the same button again.

Storing stations in memory

You can use one of the following two methods to store broadcasting stations in memory.

- Automatic preset of FM stations: SSM (Strong-station Sequential Memory)
- Manual preset of both FM and AM stations

FM station automatic preset: SSM

You can preset 6 local FM stations in each FM band (FM1, FM2, and FM3).

- 1 Select the FM band (FM1 – 3) you want to store FM stations into.



- 2 Press and hold both buttons for more than 2 seconds.

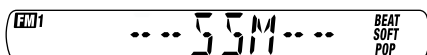
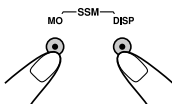

“SSM” appears, then disappears when automatic preset is over.

Local FM stations with the strongest signals are searched and stored automatically in the band number you have selected (FM1, FM2, or FM3). These stations are preset in the number buttons —No.1 (lowest frequency) to No.6 (highest frequency).

When automatic preset is over, the station stored in number button 1 will be automatically tuned in.

Manual preset

You can preset up to 6 stations in each band (FM1, FM2, FM3, and AM) manually.

Ex.: Storing FM station of 92.5 MHz into the preset number 1 of the FM1 band.

- 1 Select the band (FM1 – 3, AM) you want to store stations into (in this example, FM1).

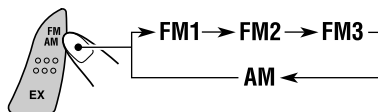

- 2 Tune in to a station (in this example, of 92.5 MHz).

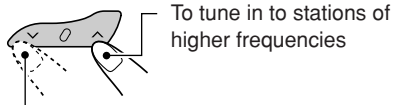

To tune in to stations of higher frequencies

To tune in to stations of lower frequencies



- 3 Press and hold the number button (in this example, 1) for more than 2 seconds.

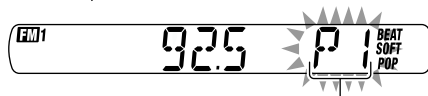
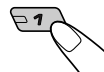

Preset number flashes for a while.

CONTINUED ON THE NEXT PAGE



4 Repeat the above procedure to store other stations into other preset numbers.

Notes:

- A previously preset station is erased when a new station is stored in the same preset number.
- Preset stations are erased when the power supply to the memory circuit is interrupted (for example, during battery replacement). If this occurs, preset the stations again.

Tuning in to a preset station

You can easily tune in to a preset station. Remember that you must store stations first. If you have not stored them yet, see “Storing stations in memory” on pages 7 and 8.

1 Select the band (FM1 – 3, AM).

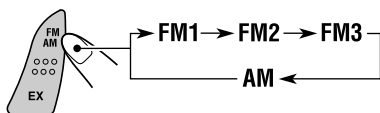

2 Select the number (1 – 6) for the preset station you want.

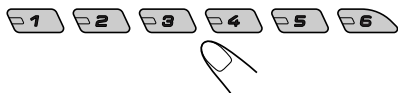

Storing your favorite station in to the one-touch operation button (EX—extra)

You can preset an FM or AM station (such as your favorite station or traffic announcement station); and recall it by one touch operation even if the unit is turned off.

Ex.: Storing an FM station of 92.5 MHz in to the one-touch operation button (EX).

1 Select the band (FM1 – 3, AM) you want to store stations into (in this example, FM1).

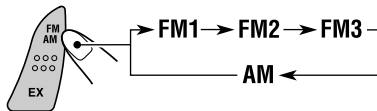

2 Tune in to a station (in this example, of 92.5 MHz).

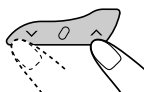

3 Press and hold the button for more than 2 seconds.

“P0” flashes on the display, showing that the station has been preset.

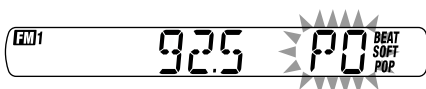
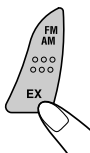

Notes:

- A previously preset station is erased when a new station is stored in the EX button.
- The preset station is erased when the power supply to the memory circuit is interrupted (for example, during battery replacement). If this occurs, preset the station again.

To tune into the favorite station

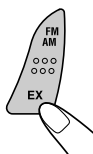

The unit automatically turns on (if it has been off).

Your favorite station is tuned in—except when the tape is playing.

- If you press the button again, the last received station will be tuned in.

TAPE OPERATIONS

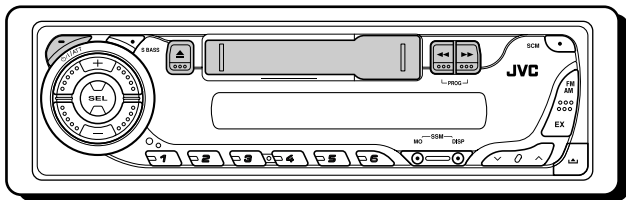

Listening to a cassette

You can play back type I (normal) tapes.

1 Turn on the power.



Note on One-Touch Operation:

When a cassette is already in the cassette compartment, tape play starts automatically. However, it is not recommended to leave the cassette in the compartment when turning off the power. It may damage the tape head and the cassette.

2 Insert a cassette into the cassette compartment.

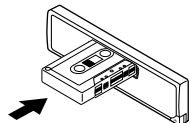

When one side of the tape reaches its end during play, the other side of the tape automatically starts playing. (Auto Reverse)

3 Select the tape direction.



Press both buttons at the same time. Each time you press both buttons, the tape direction changes alternately—forward (TAPE >>>) and reverse (TAPE <<<).

To stop play and eject the cassette

Press ▲.

Tape play stops, the cassette automatically ejects from the cassette compartment. The source changes to the previously selected one.

- You cannot change the source if the cassette is still in the cassette compartment. To change the source, you must eject the cassette first.
- You can also eject the cassette by pressing ▲ while the unit is turned off.

To fast wind a tape

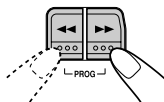

Press in ►► or ◀◀.

The tape will be wound in the direction of the arrows (◀;▶ or ▶;◀).



To restart playback, lightly press the other button which is not pressed in (◀◀ or ►►).

SOUND ADJUSTMENTS

Adjusting the sound

You can adjust the sound characteristics to your preference.

1 Select the item you want to adjust.



Each time you press the button, the adjustable items change as follows:

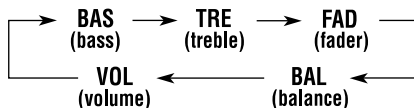

Indication	To do:	Range
BAS (Bass)	Adjust the bass.	-6 (min.) +6 (max.)
TRE (Treble)	Adjust the treble.	-6 (min.) +6 (max.)
FAD*1 (Fader)	Adjust the front and rear speaker balance.	R6 (Rear only) F6 (Front only)
BAL (Balance)	Adjust the left and right speaker balance.	L6 (Left only) R6 (Right only)
VOL*2 (Volume)	Adjust the volume.	00 (min.) 50 (max.)

*1 If you are using a two-speaker system, set the fader level to "00."

*2 Normally, the + and - buttons work as the volume control buttons. So you do not have to select "VOL" to adjust the volume level.

2 Adjust the level.

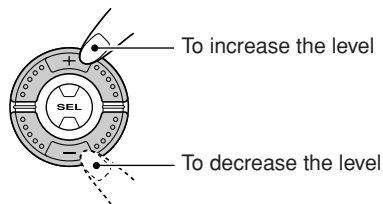

Ex.: When you select "TRE" (treble)

3 Repeat steps 1 and 2 to adjust the other items.

Turning on/off the super bass function

The super bass function allows you to maintain the richness and fullness of the bass sound regardless of how low you set the volume.



Each time you press the button, the function turns on and off alternately.

S-BASS indicator

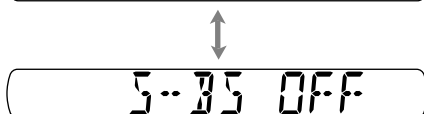
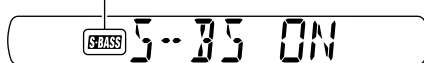



Selecting preset sound modes

You can select a preset sound adjustment suitable to the music genre.

Select the sound mode you want.

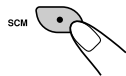

Each time you press the button, the sound mode changes as follows:

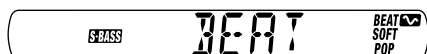

Ex.: When you select "BEAT"

Indication	For:	Preset values		
		BAS	TRE	S.BASS
SCM OFF	(Flat sound)	00	00	OFF
BEAT	Rock or disco music	+2	00	ON
SOFT	Quiet background music	+1	-3	OFF
POP	Light music	+4	+1	OFF

Notes:

- You can adjust each sound mode to your preference, and store it in memory.
If you want to adjust and store your original sound mode, see "Storing your own sound adjustments" below.
- To adjust the bass and treble reinforcement levels or to turn on/off the super bass function, see page 10.

Storing your own sound adjustments

You can adjust the sound modes (BEAT, SOFT, POP) to your preference and store your own adjustments in memory.

- There is a time limit in doing the following procedure. If the setting is canceled before you finish, start from step 1 again.

1 Call up the sound mode you want to adjust.



- See on the left column for details.

2 To adjust the bass or treble level.

- Select "BAS" (bass) or "TRE" (treble).



- Adjust the level.



To turn on or off the super bass function.



- See page 10 for details.

3 Repeat step 2 to adjust the other items.

4 Press and hold SCM until the sound mode you have selected in step 1 flashes on the display.

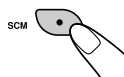

Your adjustment made for the selected sound mode is stored in memory.

5 Repeat the same procedure to store other sound modes.

To reset to the factory settings, repeat the same procedure and reassign the preset values listed in the table on the left column.

DETACHING THE CONTROL PANEL

You can detach the control panel when leaving the car.

When detaching or attaching the control panel, be careful not to damage the connectors on the back of the control panel and on the panel holder.

Detaching the control panel

Before detaching the control panel, be sure to turn off the power.

1 Unlock the control panel.

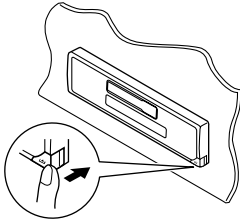

2 Lift and pull the control panel out of the unit.

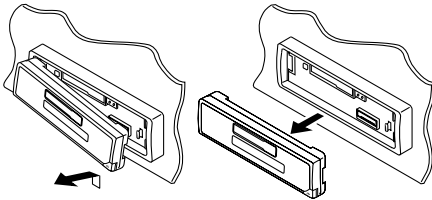

3 Put the detached control panel into the provided case.

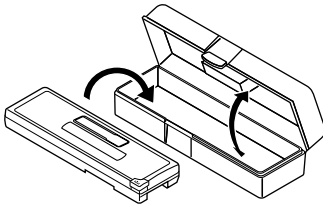

Attaching the control panel

1 Insert the left side of the control panel into the groove on the panel holder.

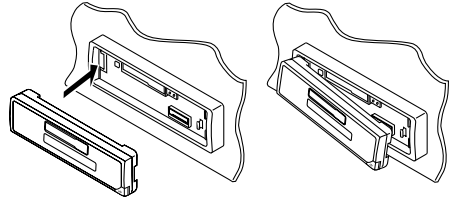

2 Press the right side of the control panel to fix it to the panel holder.

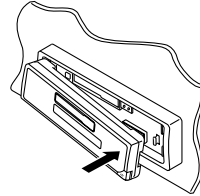

Note on cleaning the connectors:

If you frequently detach the control panel, the connectors will deteriorate.

To minimize this possibility, periodically wipe the connectors with a cotton swab or cloth moistened with alcohol, being careful not to damage the connectors.

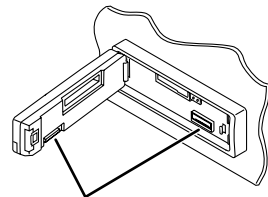

Connectors

TROUBLESHOOTING

What appears to be trouble is not always serious. Check the following points before calling a service center.

	Symptoms	Causes	Remedies
General	• Sound cannot be heard from the speakers.	The volume level is set to the minimum level.	Adjust it to the optimum level.
		Connections are incorrect.	Check the cords and connections.
	• This unit does not work at all.	The built-in microcomputer may have functioned incorrectly due to noise, etc.	While holding SEL, press  /I/ATT for more than 2 seconds to reset the unit. (Your preset adjustments will also be erased.) (See page 2.)
FM/AM	• SSM (Strong-station Sequential Memory) automatic preset does not work.	Signals are too weak.	Store stations manually.
	• Static noise while listening to the radio.	The antenna is not connected firmly.	Connect the antenna firmly.
Tape Playback	• A cassette tape cannot be inserted.	You have tried to insert a cassette in the wrong way.	Insert the cassette with the exposed tape facing right.
	• Cassette tapes become hot.	This is not a malfunction.	_____
	• Tape sound is at very low level and sound quality is degraded.	The tape head is dirty.	Clean it with a head cleaning tape.



MAINTENANCE

This unit requires very little attention, but you will be able to extend the life of the unit if you follow the instructions below.

To clean the head

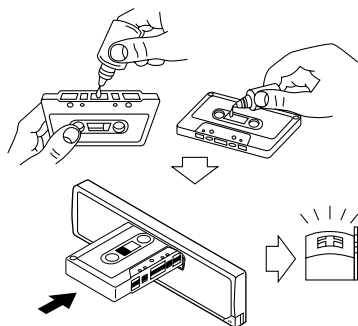

- Clean the heads after every 10 hours of use using a wet-type head cleaning tape (available at an audio store).
When the head becomes dirty, you may realize the following symptoms:
 - Sound quality is reduced.
 - Sound level decreases.
 - Sound drops out.
- Do not play dirty or dusty tapes.
- Do not touch the highly-polished head with any metallic or magnetic tools.

To keep the tape clean

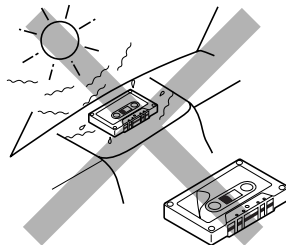

- Always store the cassettes in their storage cases after use.
- Do not store cassettes in the following places:
 - Subject to direct sunlight
 - With high humidity
 - At extremely hot temperatures

CAUTION:

- *Do not play the cassettes with peeling labels; otherwise, they can damage the unit.*
- *Tighten tapes to remove slack since loose tape may become entangled with the mechanism.*
- *Do not leave a cassette in the cassette compartment after use, as the tape may become slack.*

SPECIFICATIONS

AUDIO AMPLIFIER SECTION

Maximum Power Output:

Front: 45 W per channel

Rear: 45 W per channel

Continuous Power Output (RMS):

Front: 17 W per channel into 4 Ω , 40 Hz to 20 000 Hz at no more than 0.8% total harmonic distortion.

Rear: 17 W per channel into 4 Ω , 40 Hz to 20 000 Hz at no more than 0.8% total harmonic distortion.

Load Impedance: 4 Ω (4 Ω to 8 Ω allowance)

Tone Control Range:

Bass: ± 10 dB at 100 Hz

Treble: ± 10 dB at 10 kHz

Frequency Response: 40 Hz to 20 000 Hz

Signal-to-Noise Ratio: 70 dB

Line-Out Level/Impedance:

1.0 V/20 k Ω load (250 nWb/m)

TUNER SECTION

Frequency Range:

FM: 87.5 MHz to 108.0 MHz

AM: 531 kHz to 1 602 kHz

[FM Tuner]

Usable Sensitivity:

11.3 dBf (1.0 μ V/75 Ω)

50 dB Quieting Sensitivity:

16.3 dBf (1.8 μ V/75 Ω)

Alternate Channel Selectivity (400 kHz):

65 dB

Frequency Response: 40 Hz to 15 000 Hz

Stereo Separation: 35 dB

Capture Ratio: 2.0 dB

[AM Tuner]

Sensitivity: 20 μ V

Selectivity: 35 dB

CASSETTE DECK SECTION

Wow & Flutter: 0.15% (WRMS)

Fast-Wind Time: 190 sec. (C-60)

Frequency Response: 50 Hz to 14 000 Hz
(Normal tape)

Signal-to-Noise Ratio: 52 dB

Stereo Separation: 40 dB

GENERAL

Power Requirement:

Operating Voltage: DC 14.4 V

(11 V to 16 V allowance)

Grounding System: Negative ground

Allowable Operating Temperature: 0°C to +40°C

Dimensions (W \times H \times D):

Installation Size (approx.):

182 mm \times 52 mm \times 150 mm

Panel Size (approx.):

188 mm \times 58 mm \times 11 mm

Mass (approx.):

1.3 kg (excluding accessories)

Design and specifications are subject to change without notice.



Having TROUBLE with operation?

Please reset your unit

Refer to page of How to reset your unit

JVC



EN

© 2005 Victor Company of Japan, Limited

0105DTSMDTJEIN

JVC KS-FX384/KS-F184

Installation/Connection Manual

GET0308-002A
[U]

0105DTSMDTJEIN
EN

This unit is designed to operate on 12 V DC, **NEGATIVE ground electrical systems**. If your vehicle does not have this system, a voltage inverter is required, which can be purchased at JVC car audio dealers.

Parts list for installation and connection

The following parts are provided for this unit.
After checking them, please set them correctly.

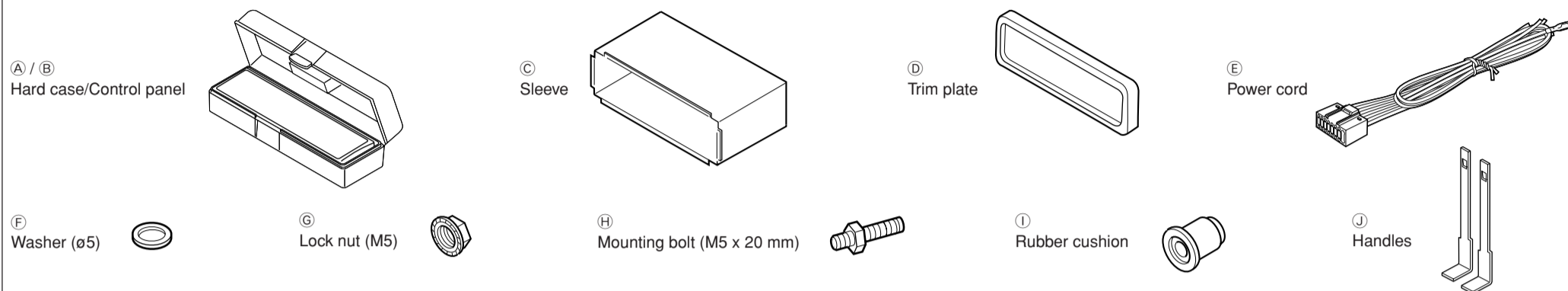

INSTALLATION (IN-DASH MOUNTING)

The following illustration shows a typical installation. If you have any questions or require information regarding installation kits, consult your JVC car audio dealer or a company supplying kits.

• If you are not sure how to install this unit correctly, have it installed by a qualified technician.

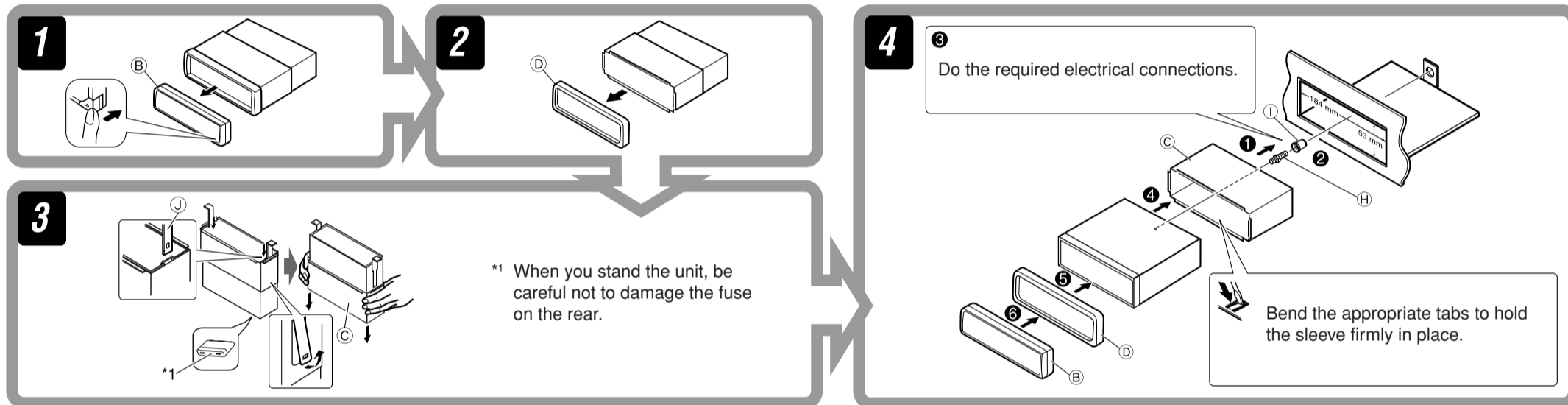

Removing the unit

Before removing the unit, release the rear section.

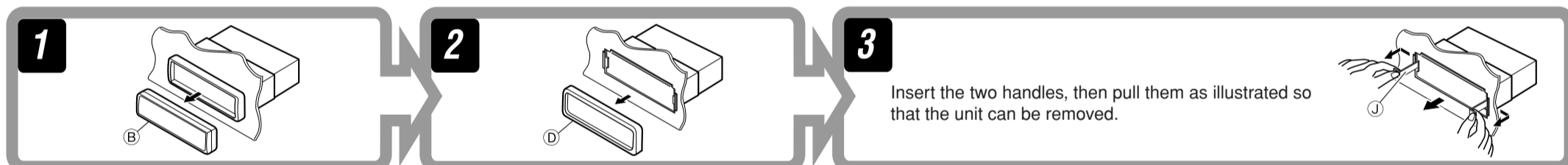

When using the optional stay

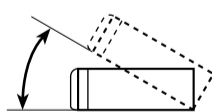
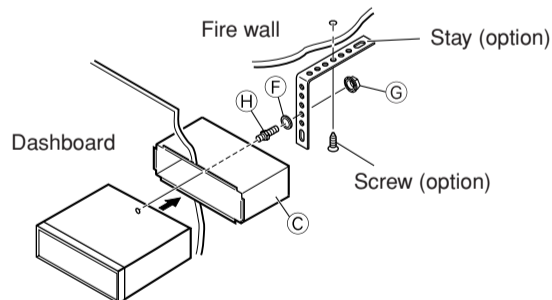

Install the unit at an angle of less than 30°.

When installing the unit without using the sleeve

In a Toyota for example, first remove the car radio and install the unit in its place.

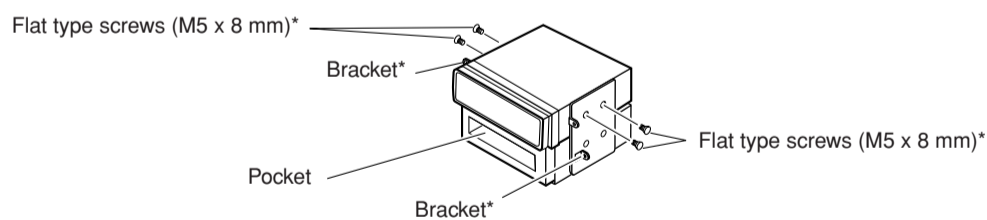

* Not included for this unit.

Note : When installing the unit on the mounting bracket, make sure to use the 8 mm-long screws. If longer screws are used, they could damage the unit.

TROUBLESHOOTING

- **The fuse blows.**
* Are the red and black leads connected correctly?
- **Power cannot be turned on.**
* Is the yellow lead connected?
- **No sound from the speakers.**
* Is the speaker output lead short-circuited?
- **Sound is distorted.**
* Is the speaker output lead grounded?
* Are the “-” terminals of L and R speakers grounded in common?
- **Noise interfere with sounds.**
* Is the rear ground terminal connected to the car’s chassis using shorter and thicker cords?
- **Unit becomes hot.**
* Is the speaker output lead grounded?
* Are the “-” terminals of L and R speakers grounded in common?
- **This unit does not work at all.**
* Have you reset your unit?

ELECTRICAL CONNECTIONS

To prevent short circuits, we recommend that you disconnect the battery's negative terminal and make all electrical connections before installing the unit.

• **Be sure to ground this unit to the car's chassis again after installation.**

Notes:

- Replace the fuse with one of the specified rating. If the fuse blows frequently, consult your JVC car audio dealer.
- Maximum input of the speakers should be more than 45 W at the rear and 45 W at the front, with an impedance of **4 Ω to 8 Ω**.
- To prevent short-circuit, cover the terminals of the UNUSED leads with insulating tape.
- The heat sink becomes very hot after use. Be careful not to touch it when removing this unit.

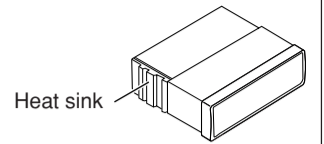

A Typical Connections

Before connecting: Check the wiring in the vehicle carefully. Incorrect connection may cause serious damage to this unit. The leads of the power cord and those of the connector from the car body may be different in color.

- 1 Connect the colored leads of the power cord in the order specified in the illustration below.
- 2 Connect the antenna cord.
- 3 Finally connect the wiring harness to the unit.

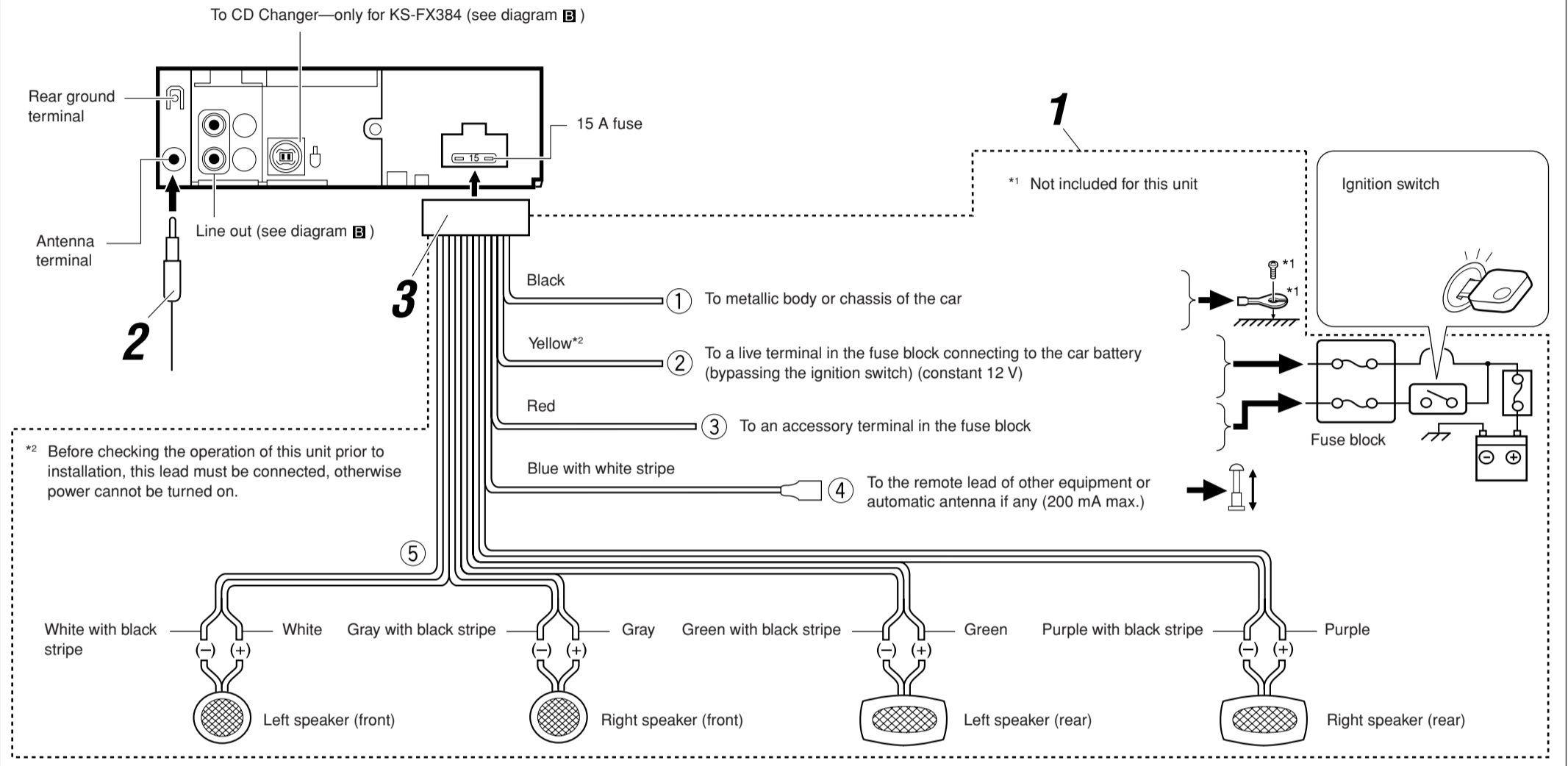

B Connections Adding Other Equipment

Amplifier

You can connect an amplifier to upgrade your car stereo system.

- Connect the remote lead (blue with white stripe) to the remote lead of the other equipment so that it can be controlled through this unit.
- **Disconnect the speakers from this unit, connect them to the amplifier. Leave the speaker leads of this unit unused.**

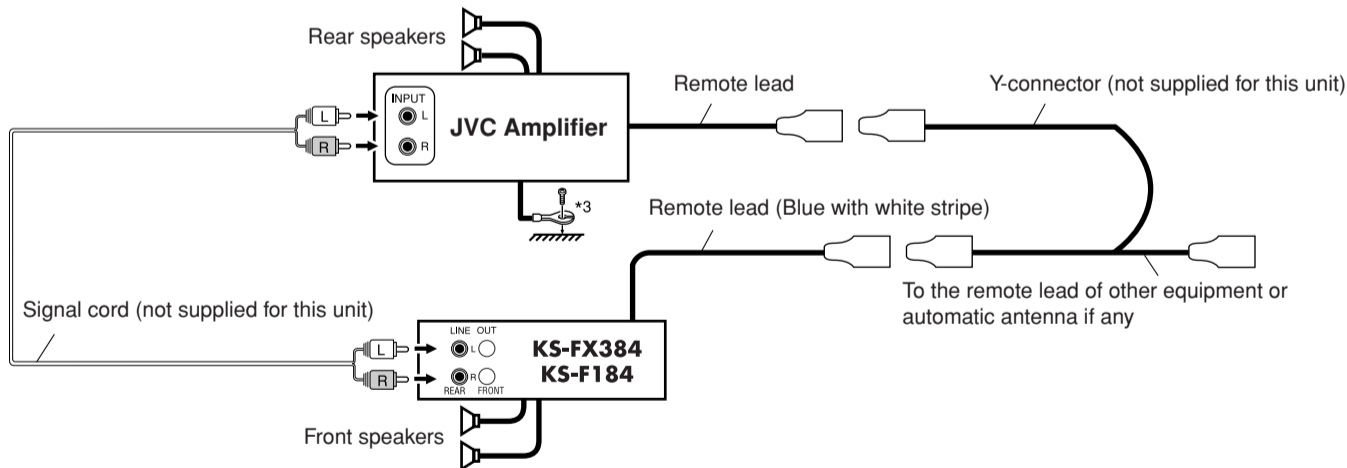

CD Changer

Only for KS-FX384

Refer also to page 13 of the INSTRUCTIONS.

Connecting cord supplied for your CD changer

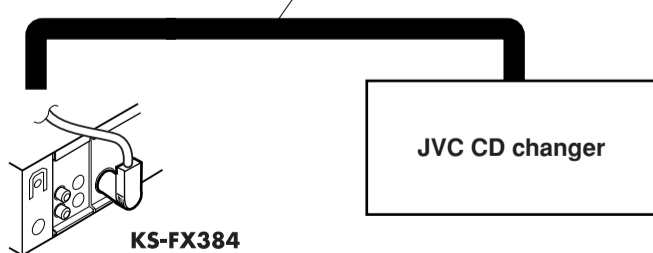

CAUTION:

- Before connecting the CD changer, make sure that the unit is turned off.

PRECAUTIONS on power supply and speaker connections:

- **DO NOT** connect the speaker leads of the power cord to the car battery; otherwise, the unit will be seriously damaged.
- **BEFORE** connecting the speaker leads of the power cord to the speakers, check the speaker wiring in your car.

